

# Uploading sensor data to ThingSpeak with Node-RED

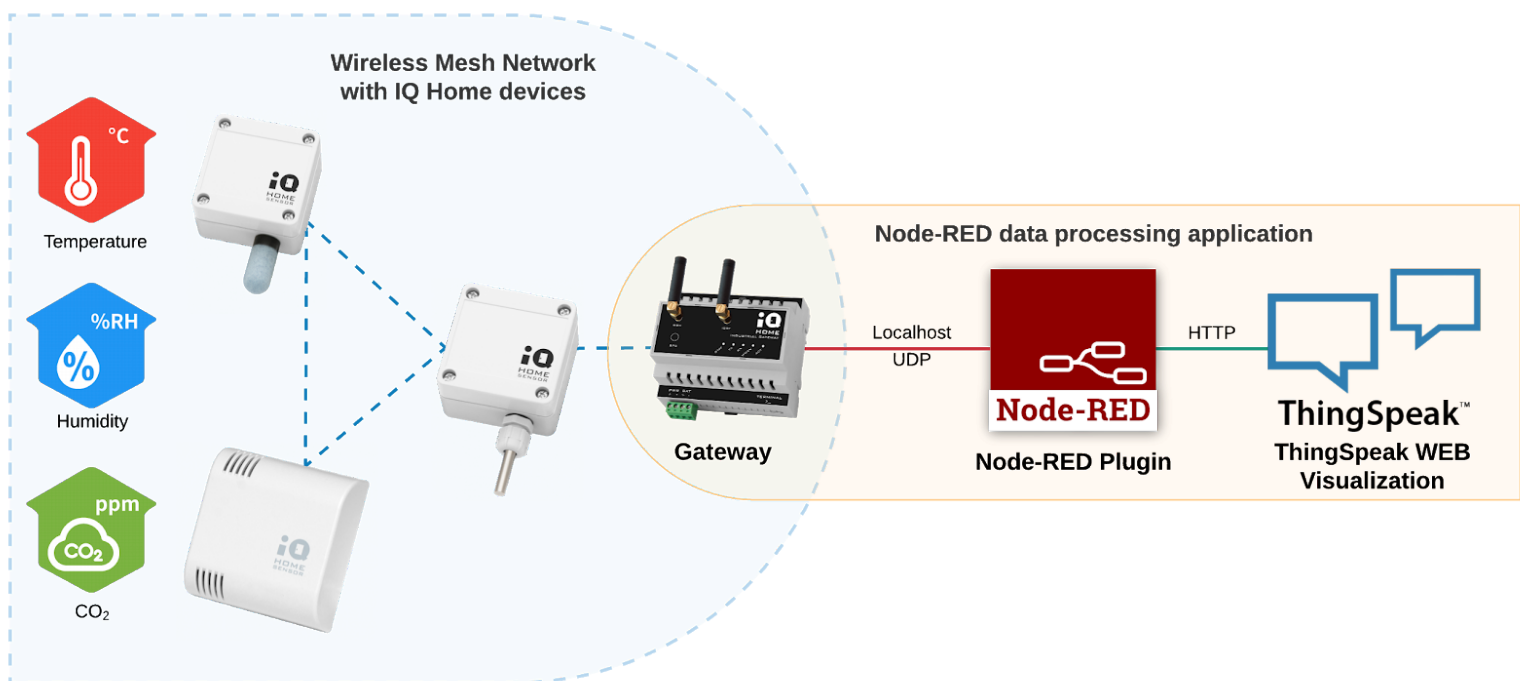

Revision: 20.09  
Date: 2020-09-29



# Contents

<b>Contents</b>	<b>2</b>
<b>1 Overview</b>	<b>3</b>
<b>2 Enable the Application Interface</b>	<b>4</b>
<b>3 Configure your Thingspeak account</b>	<b>6</b>
<b>4 Set up a Node-RED network to forward the sensor data</b>	<b>9</b>
<b>5 Demo</b>	<b>14</b>

# 1 Overview

In this guide, you will learn how to use the **ThingSpeak** free data visualization platform with your IQHome Gateway and Sensors.

The pre-installed Node-RED service and IQHome package on your Gateway will be used to periodically collect and upload your sensor data to ThingSpeak.

What you will need:

- [IQ Home Gateway](#)
- [IQ Home Sensor](#)
- [ThingSpeak Account](#)

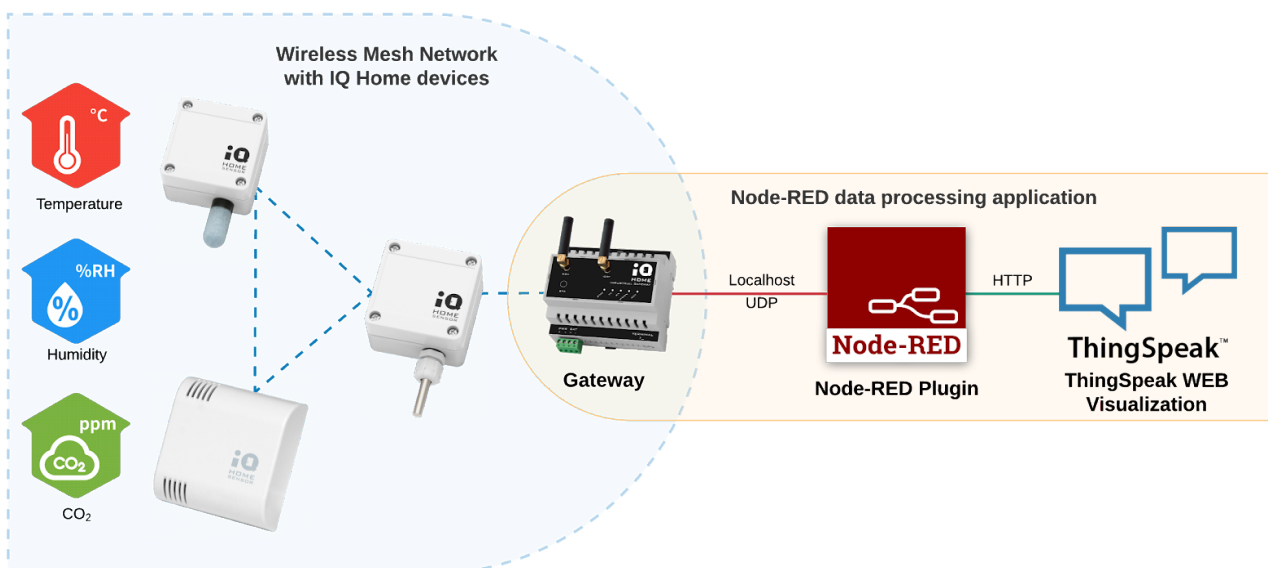

## 2 Enable the Application Interface

To connect to the Thingspeak service, first, we need to enable the Application Interface feature on the gateway.

1. Connect to the Gateway using the “**Link It!**” Software
2. Go to the “**Settings**” tab
3. Enable “**Application Interface**” and set a “**Port Send**” value (e.g. 55000)

The screenshot shows the 'Gateway Settings' page with the 'Settings' tab selected. The 'Application Interface' section is highlighted with a red box, showing the following configuration:

Setting	Value
Enable	<input checked="" type="checkbox"/>
Port listen	55001
Port send	55000

The **Port Send** value selected here will be used in Node-RED.

Then enable the Node-RED scheduler for the sensors.

1. Open the “**RF Network**” tab
2. Switch to “**Sensor Data**”
3. Click on the clock icon in the top right corner labeled “**Create Scheduler**”
4. Enable the “**Node-RED**” Response option

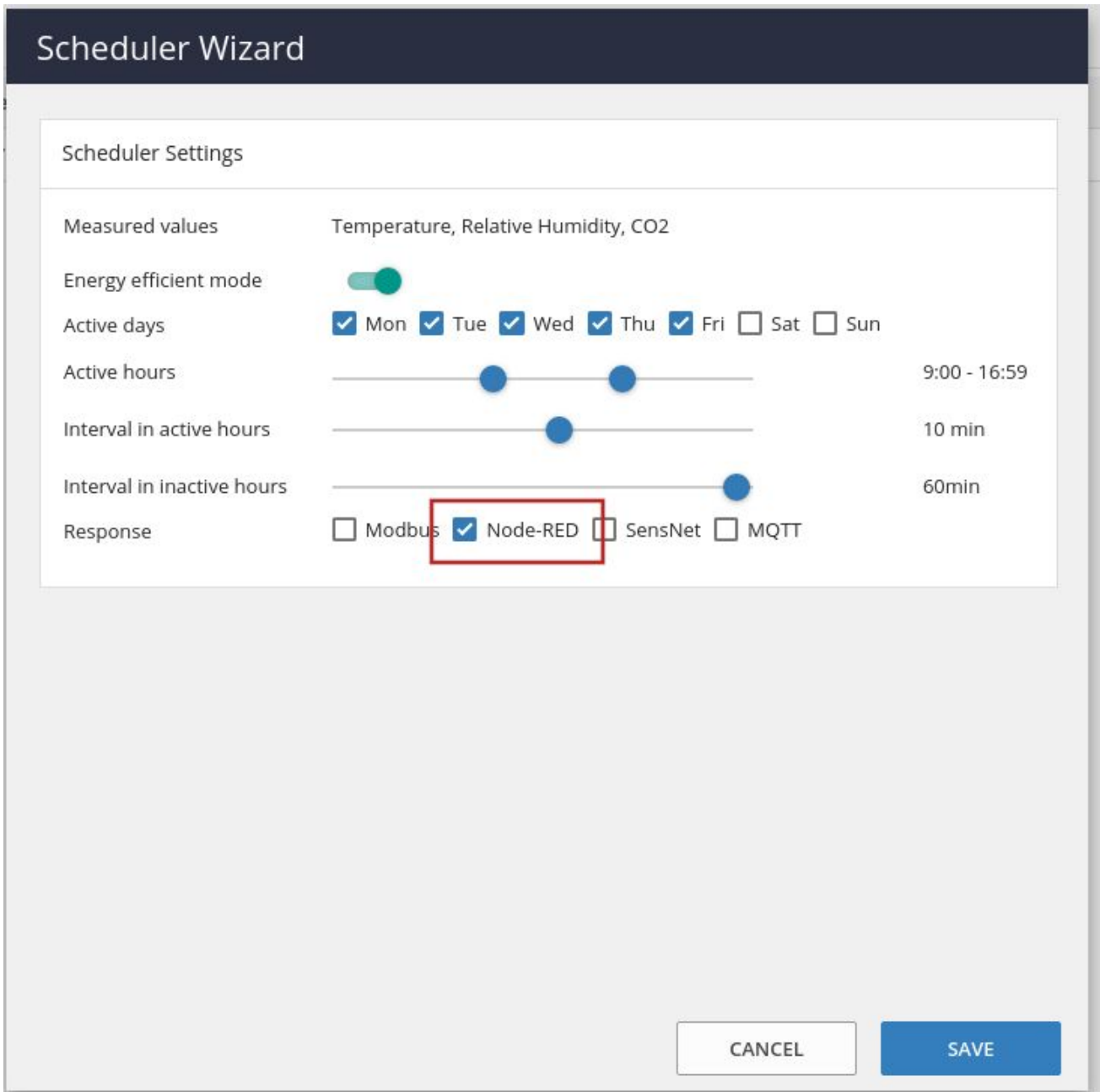

The screenshot shows the "Scheduler Wizard" interface. The "Scheduler Settings" section is visible, with the following configurations:

- Measured values: Temperature, Relative Humidity, CO2
- Energy efficient mode:
- Active days:  Mon  Tue  Wed  Thu  Fri  Sat  Sun
- Active hours: 9:00 - 16:59
- Interval in active hours: 10 min
- Interval in inactive hours: 60min
- Response:  Modbus  Node-RED  SensNet  MQTT

The "Node-RED" option is highlighted with a red box. At the bottom right, there are "CANCEL" and "SAVE" buttons.

You can also set the time intervals between the sensor measurements.

### 3 Configure your Thingspeak account

1. Open [Thingspeak](#) and log in with your existing Matlab account, or create a new account [here](#)
2. After logging in, click on **New Channel**

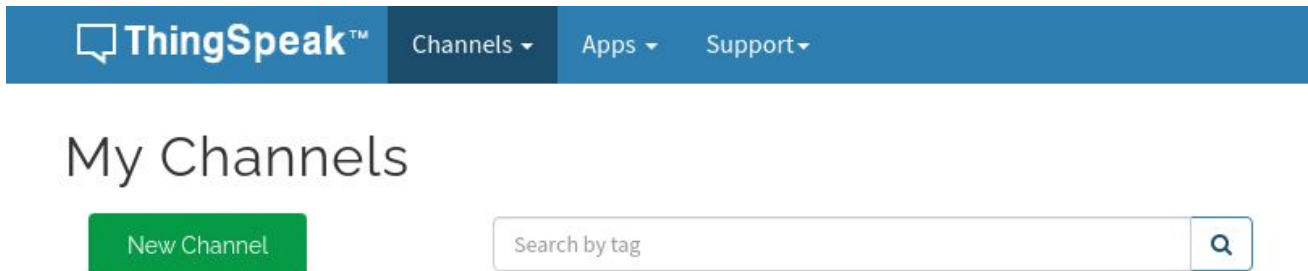

3. Give a name to your new channel, enable a field for each sensor value you would like to visualize. In this example, we are using two IQHome sensors: a **Temperature Sensor** [SI-T-02/SC] and a **Temperature and Relative Humidity Sensor** [SN-TH-02], so we enable 3 fields. You can leave the other settings empty for now. Click on **Save Channel**.

#### New Channel

Name	<input type="text" value="IQHome"/>
Description	<input type="text"/>
Field 1	<input type="text" value="temperature-1"/> <input checked="" type="checkbox"/>
Field 2	<input type="text" value="temperature-2"/> <input checked="" type="checkbox"/>
Field 3	<input type="text" value="humidity-2"/> <input checked="" type="checkbox"/>
Field 4	<input type="text"/> <input type="checkbox"/>
Field 5	<input type="text"/> <input type="checkbox"/>

4. This will create a default line graph for each of your fields.



Note the **field numbers** corresponding to your field names, they will be needed later in Node-RED.

Field Number	Field Name
1	temperature-1
2	temperature-2
3	humidity-2

5. Open the **API Keys** tab, and note down your **Write API Key**. It will be needed later in Node-RED.

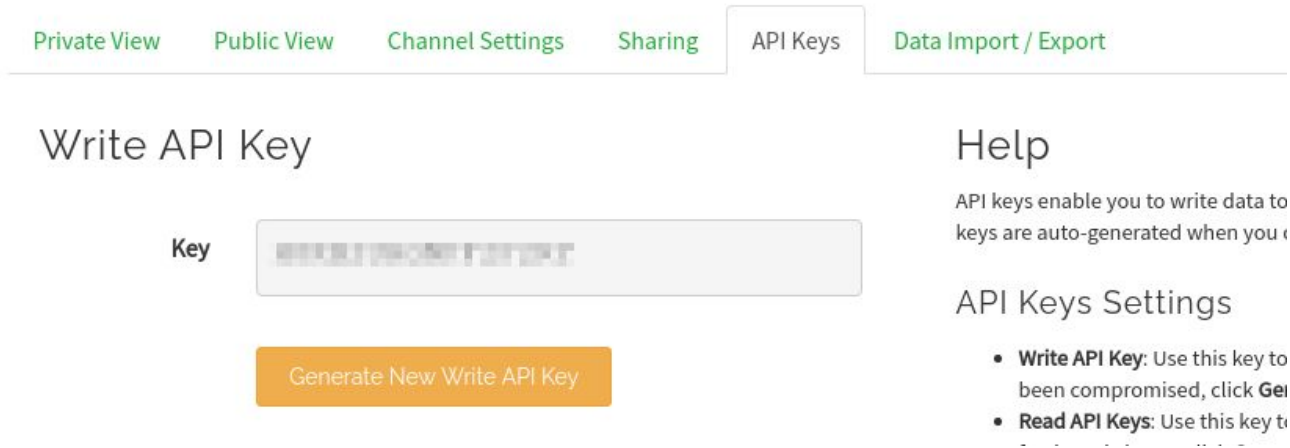
The image shows the 'API Keys' tab in the ThingSpeak interface. At the top, there are navigation tabs: 'Private View', 'Public View', 'Channel Settings', 'Sharing', 'API Keys', and 'Data Import / Export'. The 'API Keys' tab is selected. Below the navigation, the main heading is 'Write API Key'. There is a text input field labeled 'Key' containing a masked string of characters. Below the input field is an orange button labeled 'Generate New Write API Key'. To the right of the main heading, there is a 'Help' section with text explaining that API keys enable writing data and are auto-generated. Below the help section is an 'API Keys Settings' section with a list of items: 'Write API Key' (used for writing data, can be regenerated) and 'Read API Keys' (used for reading data).

**WARNING!**

If you decide to generate a new write API key, you will have to update your Node-RED configuration with your new key!



## 4 Set up a Node-RED network to forward the sensor data

For this demo, we will be using a **Temperature Sensor** [SI-T-02/SC] and a **Temperature and Relative Humidity Sensor** [SN-TH-02].

1. Switch to the **Node-RED** tab in **LinkIt!**

The **IQHome** nodes can be found in the bottom of the panel on the left side of your screen.



2. Add an iqhome **gateway** node. If you changed the used port in the first step, you can set it here by double-clicking on the node

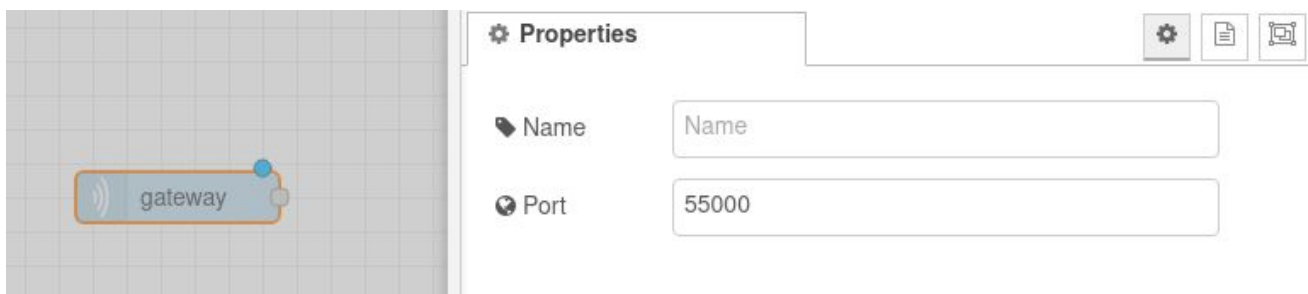

3. Add the sensor nodes corresponding to the sensors you are using in your IQHome network. In this example, we are using the **SI-T-02/SC** and **SN-TH-02** sensors, so we will add the **SI-T** and **SN-TH** nodes

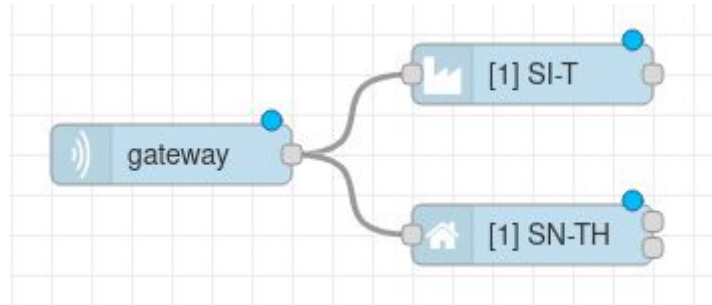

4. Set the **device addresses** corresponding to your sensor's addresses as seen in the **LinkIt! RF Network** tab by double-clicking the sensor nodes. We are using the default topic names generated by the sensor nodes, so you can leave the boxes under "Topics" empty.

#### Note

You can use custom topic names, but you must use the same topics in the **Thingspeak** node in the next step. However, these do not have to match field names written to the Thingspeak website.

#### Note

You can easily identify your sensors and their device addresses by using the "**indicate**" button in the right-click menu of the sensors under the **RF Network** tab in **LinkIt!** and finding the blinking LED on the sensor.

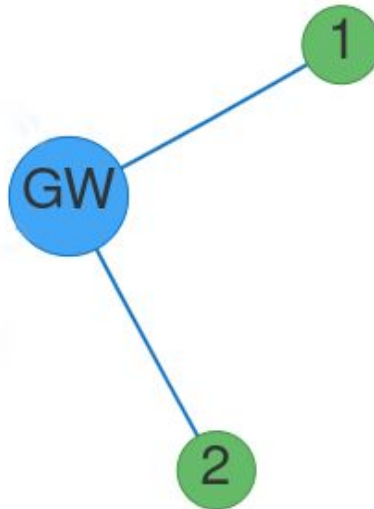

Each sensor node has outputs depending on what types of measurements can that sensor make.



5. Add a **Thingspeak** node and connect it to the outputs of the sensor nodes.

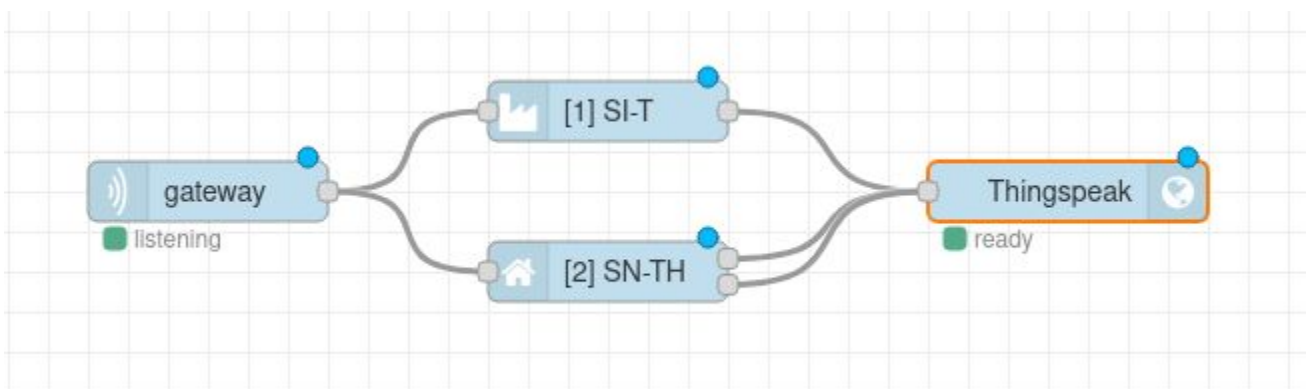

- Double click the **Thingspeak** node and enter your Thingspeak **API Key**. Then enter the same topic names as used in the sensor nodes (default {sensor type}-{device address}) to the topic numbers used on the Thingspeak website.

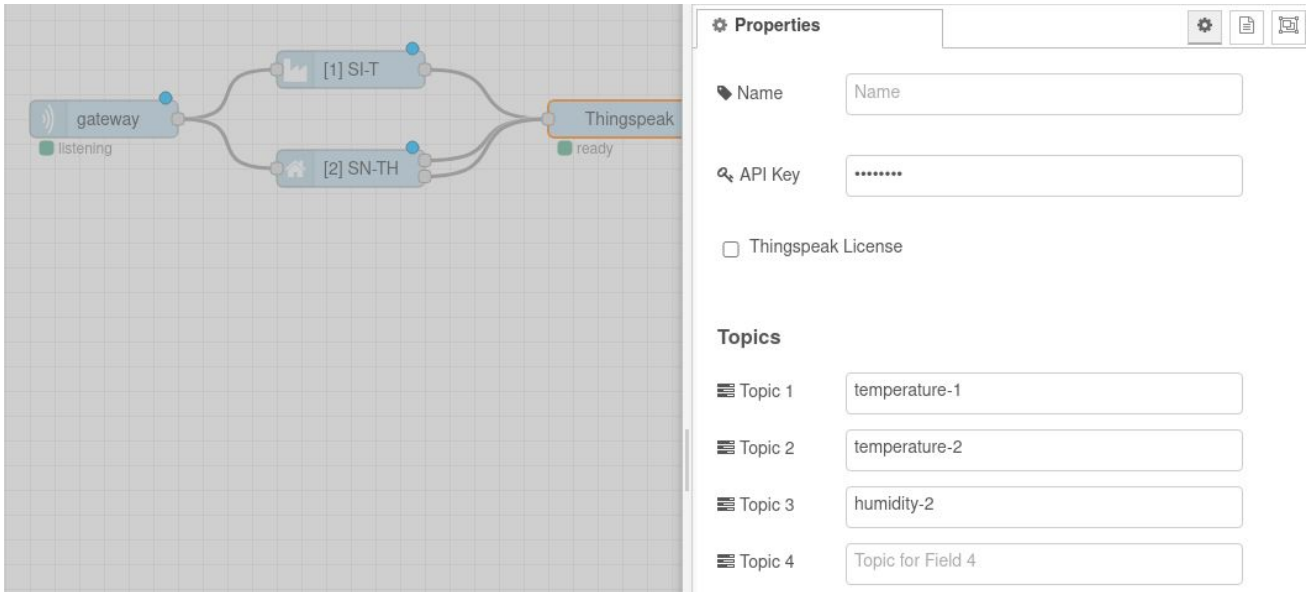

For example, The SI-T node has the device address 1 and we did not change the default topic, so it gets the output topic **temperature-1**. On the Thingspeak website, we previously set the label **temperature-1** for **Field 1**. Thus we have to set the **Topic 1** in the Thingspeak node to the topic of the sensor node: **temperature-1**.

☰ Topic 1	<input type="text" value="temperature-1"/>
☰ Topic 2	<input type="text" value="temperature-2"/>
☰ Topic 3	<input type="text" value="humidity-2"/>

Node-RED Thingspeak configuration

<b>Field 1</b>	<input type="text" value="temperature-1"/>	<input checked="" type="checkbox"/>
<b>Field 2</b>	<input type="text" value="temperature-2"/>	<input checked="" type="checkbox"/>
<b>Field 3</b>	<input type="text" value="humidity-2"/>	<input checked="" type="checkbox"/>

Thingspeak website configuration

**Note**

The Thingspeak node enforces the data limits set by Thingspeak (one request every 15 seconds). If you have an active Thingspeak (paid) subscription, you can check the Thingspeak Subscription checkbox in the Thingspeak node to enable the higher (one request every second) data rate of the paid account.

7. **Deploy** your Node-RED network by clicking the **Deploy** button in the top right corner of your window

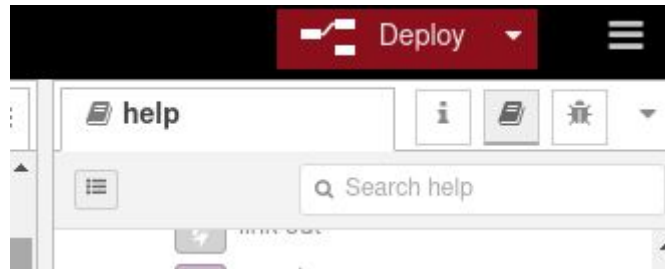

If you turn on your IQHome gateway and sensors, you will see the incoming data in your Adafruit IO Dashboard:

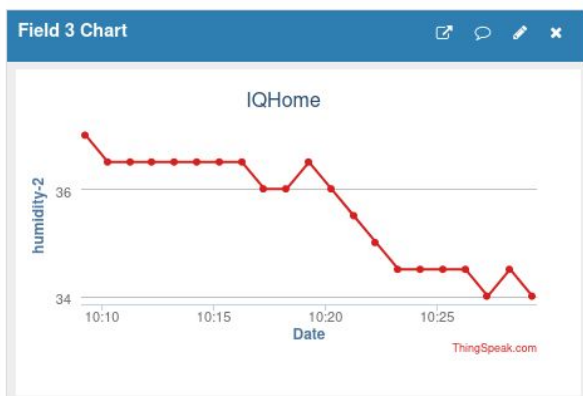
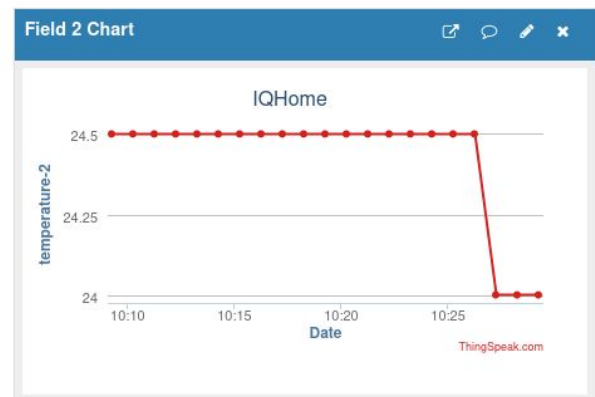
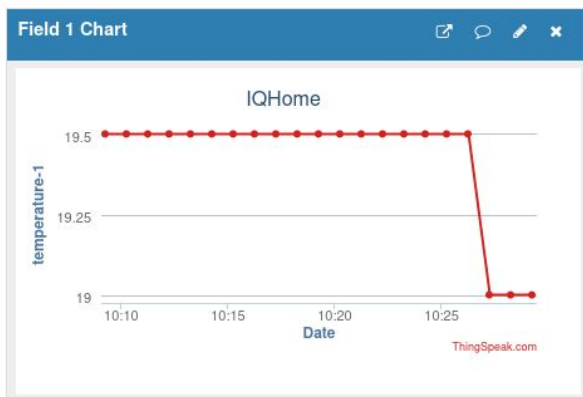

## 5 Demo

You can find our **Thingspeak** demo here:

<https://thingspeak.com/channels/1156957>